

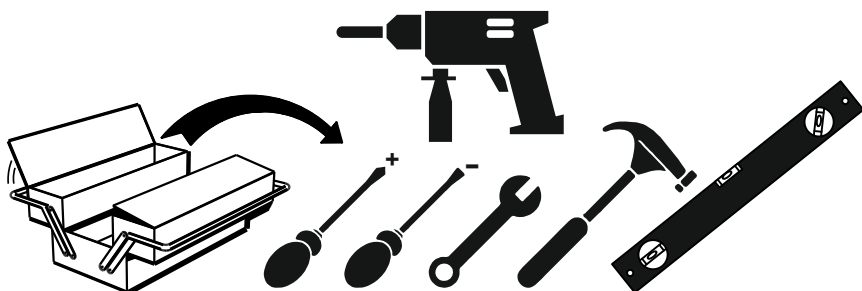

MULTIMO

107-SINGLE WARDROBE

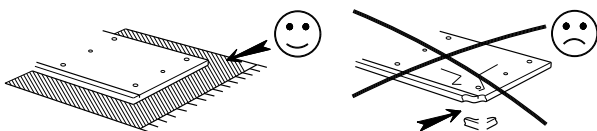

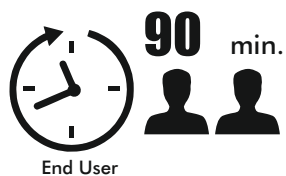
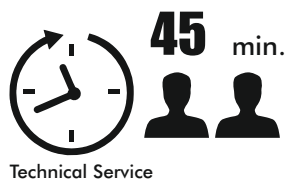
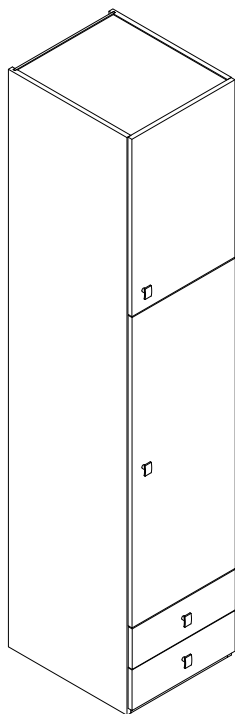

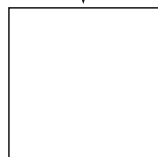







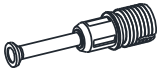

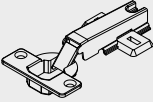

VIDEO

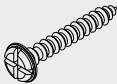
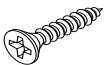
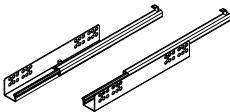

link

Track Title	Piece	(inch)			(mm)			
		Thickness	Length	Width	Piece	Thick	Height	Most
A		0,71	81,89	21,26	2	18	2080	540
B		1,18	17,32	21,22	1	30	440	539
C		0,71	17,32	20,43	3	18	440	519
D		0,71	17,32	19,69	1	18	440	500
E		0,71	27,56	18,50	1	18	700	470
F		0,71	40,35	18,50	1	18	1025	470
G		6,30	18,50	16,46	2	160	470	418
H		0,31	81,06	17,99	1	8	2059	457

Accessories List

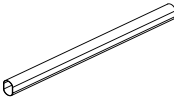
MXN 02  16 / piece	MNG - 01  16 / piece	TAP - 01  16 / piece	KVL 01  16 / piece
TS - 01  4 / piece	TSY - 01  2 / piece	VD - 02 (3,5x25) mm  12 / piece	VD - 03 (3,5x18) mm  20 / piece
RYP - 02  2 / piece	ER - 01  8 / piece	PM - 01  4 / piece	AVT - 01  4 / piece
KP - 03  4 / piece	VKP - 01 (22) mm  2 / piece	VKP - 03 (40) mm  2 / piece	AF - 02  2 / piece
BO - 01  1 / piece			

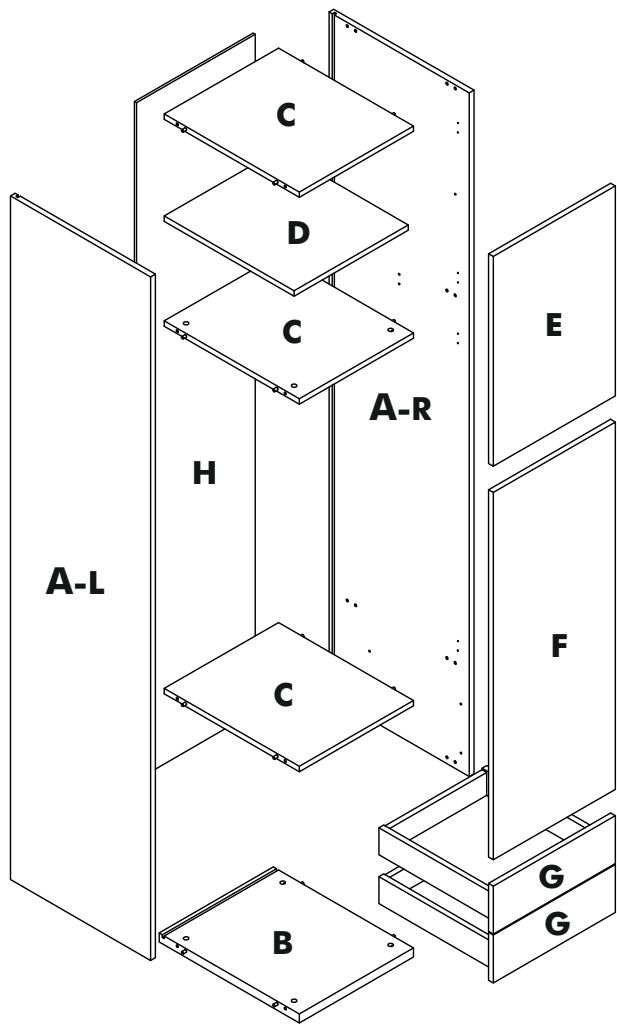

STEP 1

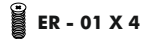
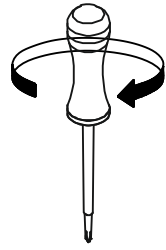
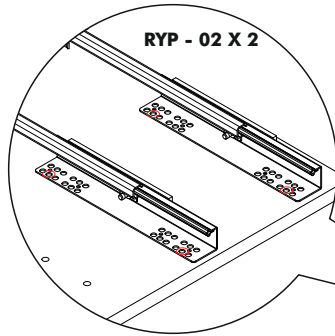
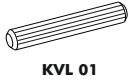

**TRACK TITLE
A LEFT / A RIGHT**

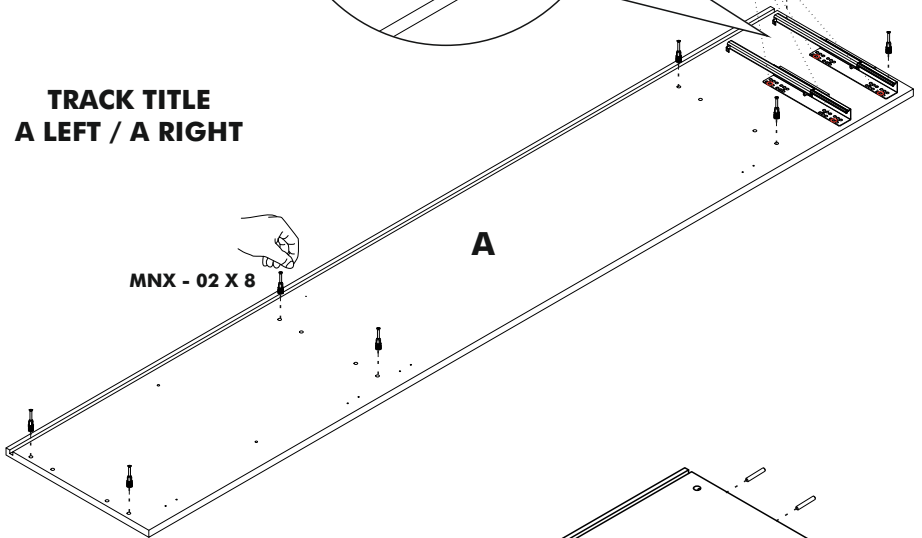

KVL - 01 X 4

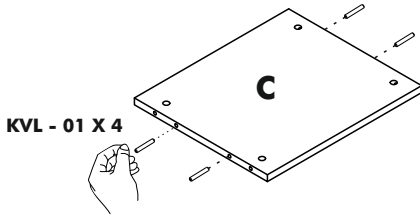

VIDEO

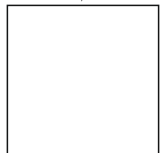

link

STEP 2

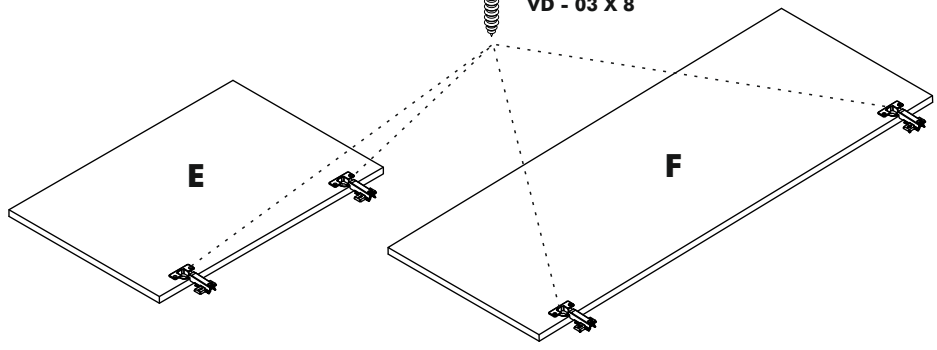
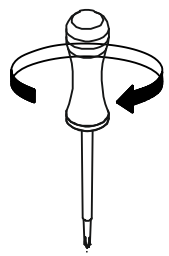
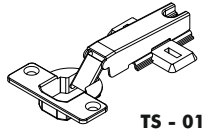

STEP 3

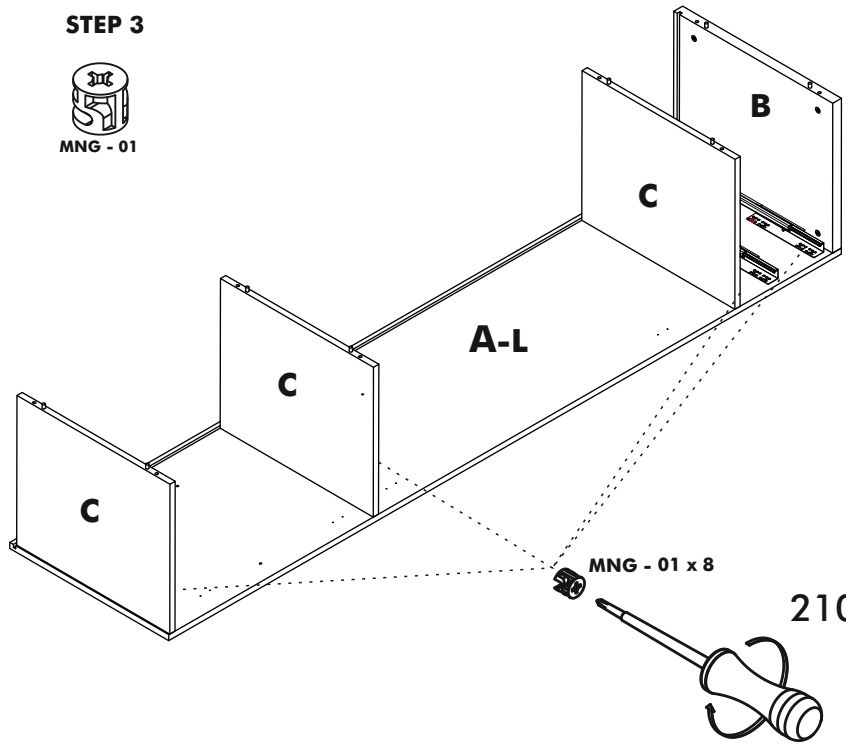

VIDEO

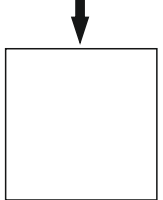

STEP 4

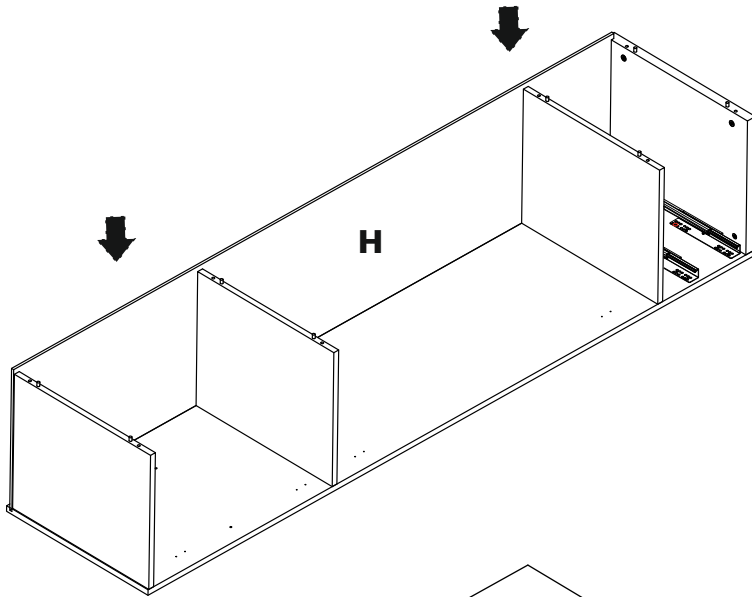

STEP 5

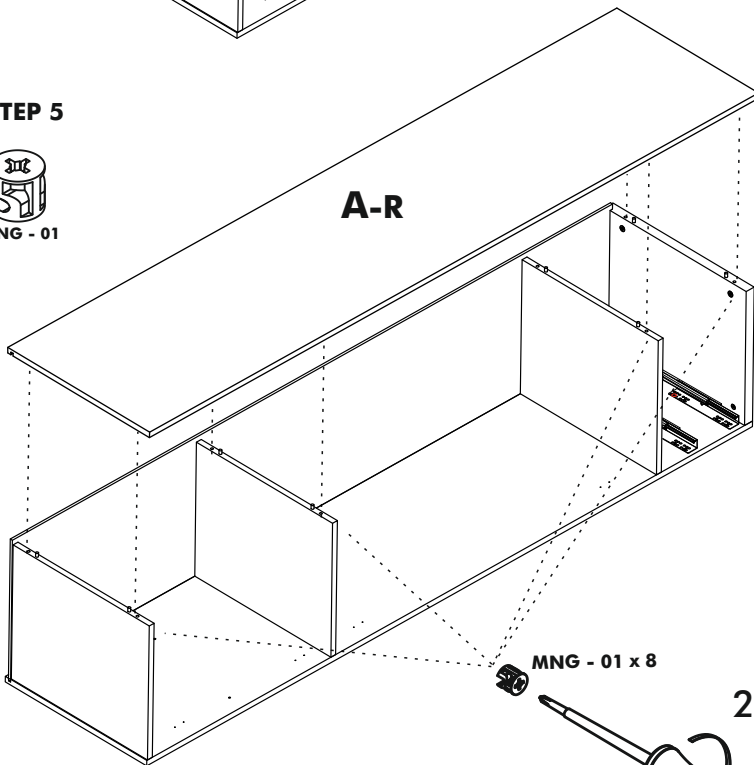

210°

VIDEO

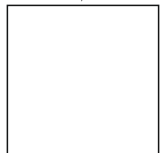

link

STEP 6

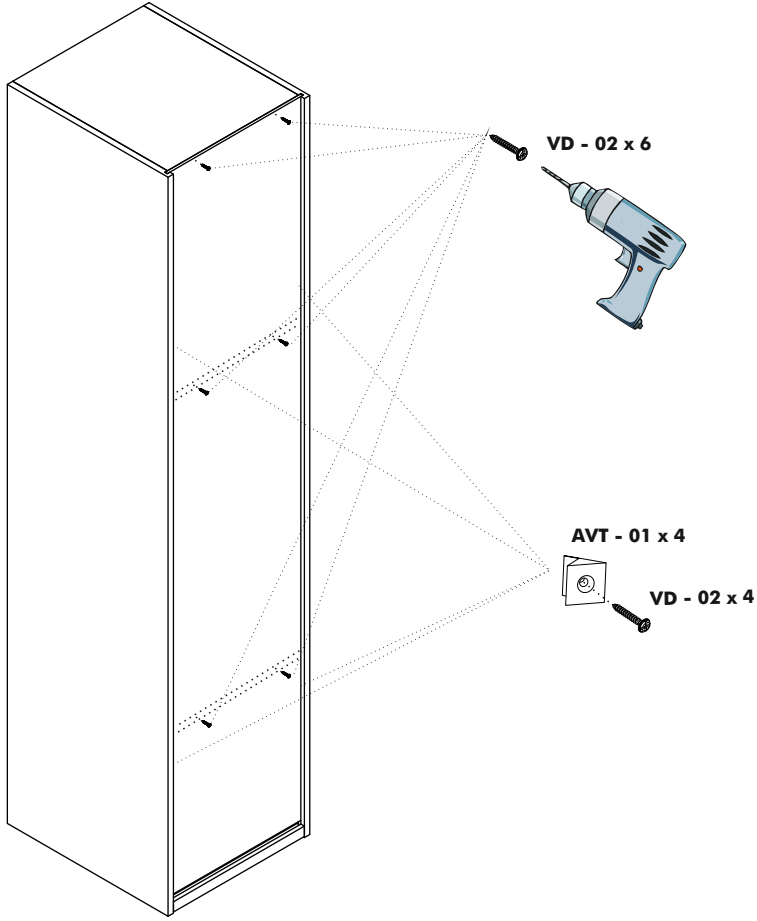

VIDEO



link

STEP 7

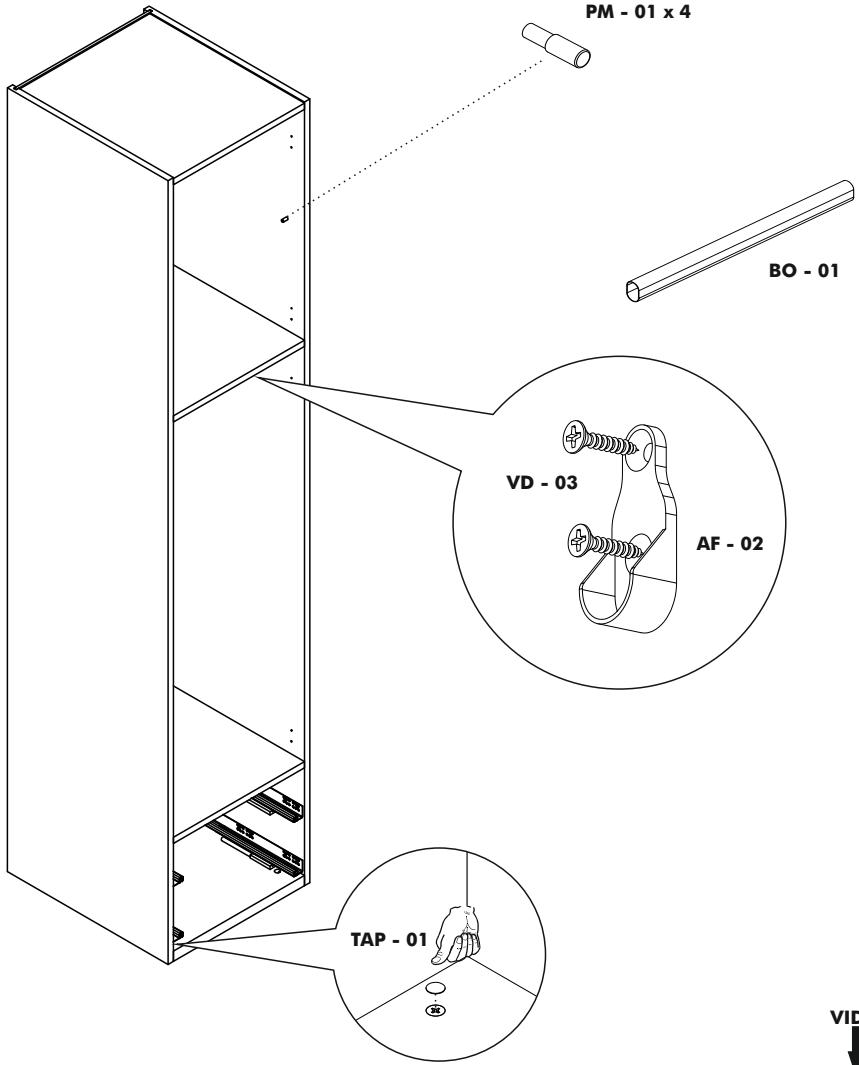

VIDEO

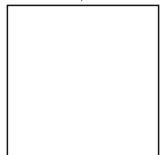

link

STEP 8

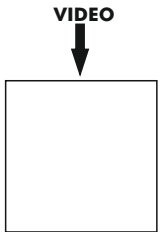
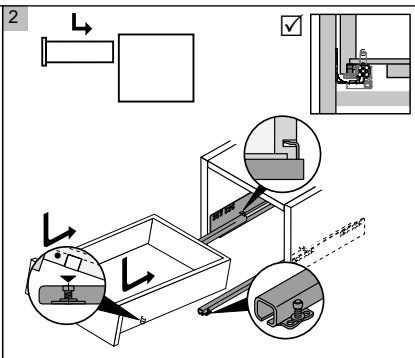
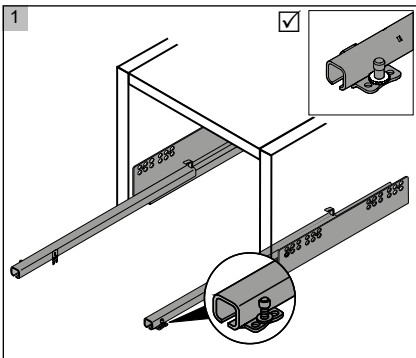
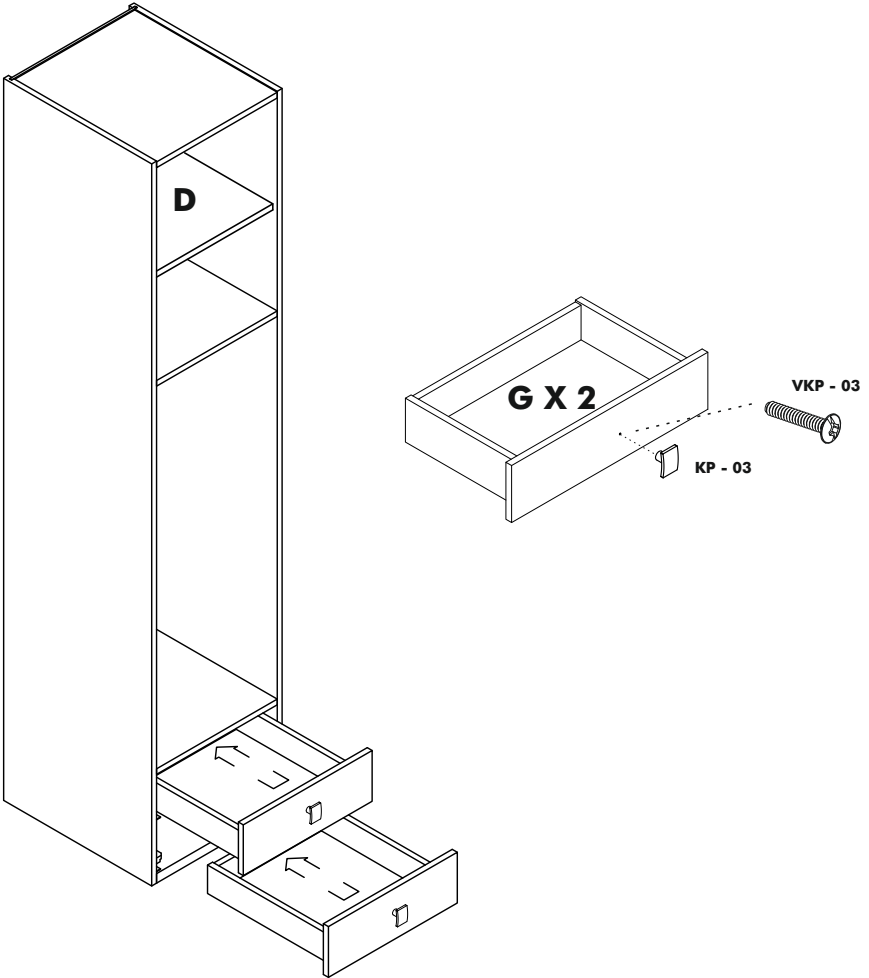

STEP 9

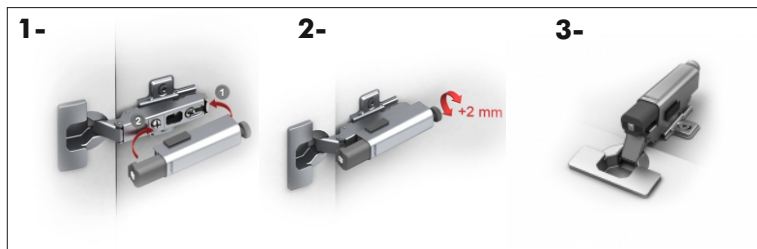
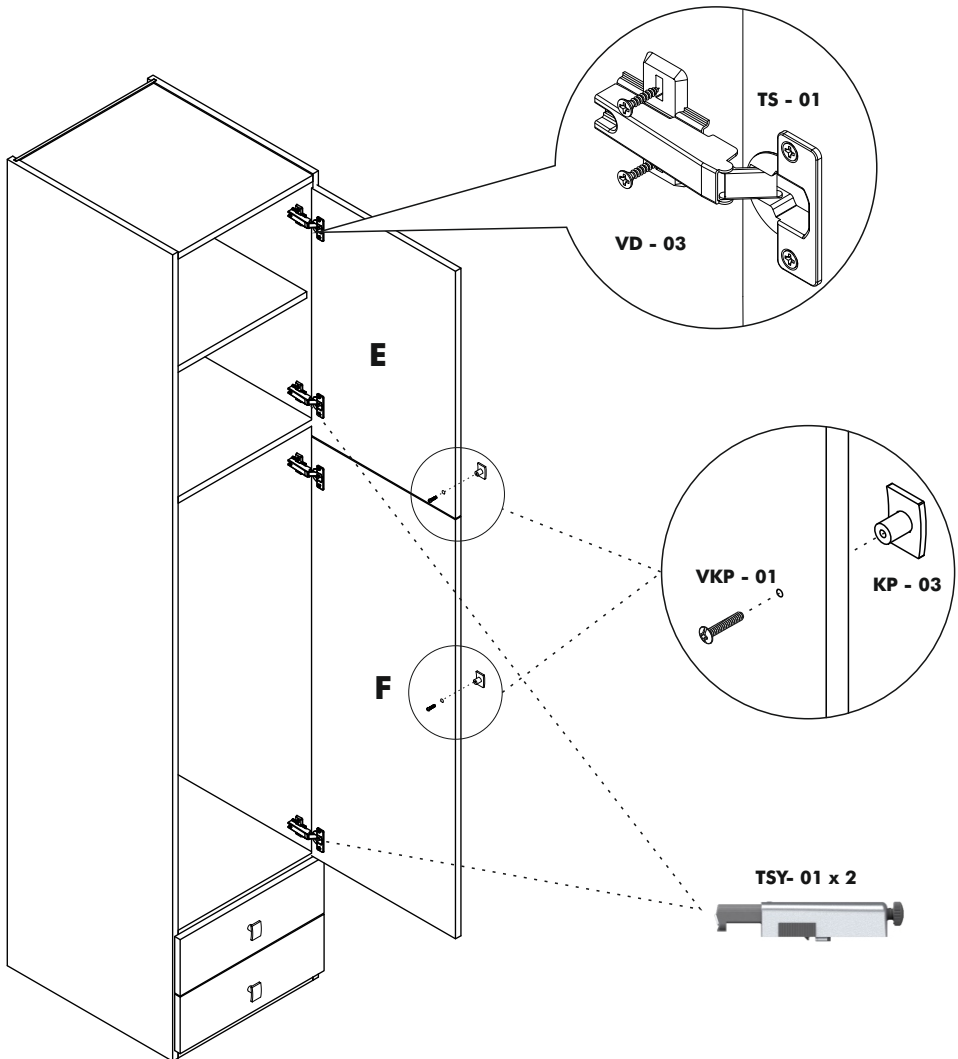

VIDEO

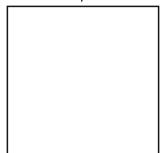

link

ATTENTION / HOW TO / READ ME / OWNER'S GUIDE

1. When mounting on a regular drywall, furniture must be fastened to wood or metal studs. Solid walls made of brick, concrete or similar strong material are also acceptable. Do not mount furniture to paper-mache or sheet rock like material without properly aaixing to stud.
2. For safety and product longevity you must periodically inspect the mounting and mechanical connections for integrity and tightness. Confirm hardware remains properly affixed and connections snug.
3. Wall Bed mattress thickness may not exceed 8 inch. Take care to remove pillows and excess blankets before closing. Doing so keeps mechanism free of obstruction and unnecessary stress.
4. Do not lean or rest heavy objects on side or top of furniture. This may cause balance issues and compromise the integrity of your mounting connections.
5. Please use the furniture's beds, desks and shelving as intended. Not designed to be sat, stood, leaned, jumped (etc) on. Improper use may cause personal injury and damage to property.
6. With seasonal humidity change you must inspect interior and exterior of furniture.
7. Single, Twin, Twin XL beds accommodate the weight of one person. Improperly sleeping more than one person risks injury to person and damage to property.
8. Before any un-mounting or disassembly please contact Multimo for technical support and instruction. Failure to properly detach risks injury to person and damage to property.
9. For Bunk Beds:
 - a. Always use provided ladder when accessing top bunk.
 - b. Be slow, careful and aware of surroundings when opening top bunk.
 - c. Do not horseplay. Beds are to be slept on only.
 - d. Some have legs that fully extend when open- be aware of where the leg is and will be.



www.multimo.com